



# ścieżka zdrowia

Fitness trial / Fitness Weg

**RÓWNOWAŻNIA ZYGZAK**

Urządzenie to wpływa idealnie na koncentrację i zmysł równowagi.

Wymiary( dł x szer x wys): 600 x 250 x 30 cm

Strefa bezpieczeństwa (dł x szer): 900 x 550 cm

KOD PRODUKTU: SZ001-10

Cena netto:

4250,00 zł

Cena brutto:

5227,50 zł

**TWISTER / PYLON / SURFER**

It operates perfectly to concentration and sense of balance.

Dimension ( length x width x height): 600 x 250 x 30 cm

Safety zone (length x width):900 x 550 cm

PRODUCT CODE: SZ001-10

**TAILLE TRAINER / HÜFT TRAINER**

Es arbeitet perfekt für die Konzentration und den Gleichgewichtssinn.

Größe (Länge x Breite x Höhe): 600 x 250 x 30 cm

Sicherheitszone (Länge x Breite): 900 x 550 cm

PRODUKT-CODE: SZ001-10

**SŁUPKI**

Urządzenie wpływa na mięśnie nóg ramion i bioder.

Wymiary( dł x szer x wys): 250 x 150 x 70 cm

Strefa bezpieczeństwa (dł x szer): 1050 x 450cm

KOD PRODUKTU: SZ001-4

Cena netto:

4500,00 zł

Cena brutto:

5535,00 zł

**THE POSTS**

The device affects the muscles of the legs, arms and hips.

Dimension ( length x width x height): 250 x 150 x 70 cm

Safety zone (length x width): 1050 x 450cm

PRODUCT CODE: SZ001-4

**DIE BEITRÄGE**

Das Gerät wirkt sich auf die Muskeln der Beine, Arme und Hüften.

Größe (Länge x Breite x Höhe): 250 x 150 x 70 cm

Sicherheitszone (Länge x Breite): 1050 x 450cm

PRODUKT-CODE: SZ001-4

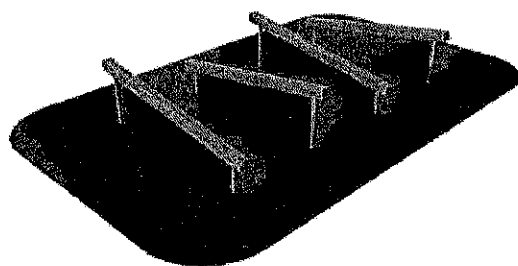
**PŁOTKI**

Doskonale wpływa na mięśnie łydek, ud i pośladków.

Wymiary( dł x szer x wys): 450 x 300 x 90 cm

Strefa bezpieczeństwa (dł x szer): 750 x 600 cm

KOD PRODUKTU: SZ001-1

Cena netto:

6000,00 zł

Cena brutto:

7380,00 zł

**HURDLES**

Perfectly affects the calf muscles, thighs and buttocks.

Dimension ( length x width x height): 450 x 300 x 90 cm

Safety zone (length x width): 750 x 600 cm

PRODUCT CODE: SZ001-1

**HÜRDENLAUF**

Perfekt wirkt sich auf die Wadenmuskulatur, Oberschenkel und Gesäß.

Größe (Länge x Breite x Höhe): 450 x 300 x 90 cm

Sicherheitszone (Länge x Breite):750 x 600 cm

PRODUKT-CODE: SZ001-1

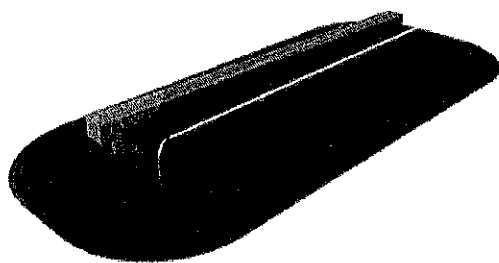
**BRZUSZKI**

Przyrząd wzmacnia mięśnie brzucha .

Wymiary( dł x szer x wys): 370 x 400 x 40 cm

Strefa bezpieczeństwa (dł x szer): 670 x 400 cm

KOD PRODUKTU: SZ001-2

Cena netto:

4300,00 zł

Cena brutto:

5289,00 zł

**CRUNCHES**

The device strengthens the abdominal muscles.

Dimension ( length x width x height): 370 x 400 x 40 cm

Safety zone (length x width): 670 x 400 cm

PRODUCT CODE: SZ001-2

**KNIRSCHT**

Das Gerät stärkt die Bauchmuskeln.

Größe (Länge x Breite x Höhe):370 x 400 x 40 cm

Sicherheitszone (Länge x Breite):670 x 400 cm

PRODUKT-CODE: SZ001-2

**RUCHOMA BELKA**

Urządzenie to wpływa idealnie na koncentrację i zmysł równowagi.

Wymiary( dł x szer x wys): 370 x 20 x 60 cm

Strefa bezpieczeństwa (dł x szer): 670 x 320 cm

KOD PRODUKTU: SZ001-11

Cena netto:

4100,00 zł

Cena brutto:

5043,00 zł

**THE MOBILE BEAM**

It operates perfectly to concentration and sense of balance.

Dimension ( length x width x height): 370 x 20 x 60 cm

Safety zone (length x width): 670 x 320 cm

PRODUCT CODE: SZ001-11

**DER MOBILE STRAHL**

Es arbeitet perfekt für die Konzentration und den Gleichgewichtssinn.

Größe (Länge x Breite x Höhe): 370 x 20 x 60 cm

Sicherheitszone (Länge x Breite): 670 x 320 cm

PRODUKT-CODE: SZ001-11

Cena netto:  
3000,00 zł  
Cena brutto:  
3690,00 zł

**BELKA DO WYPADÓW DO PRZODU**

Ćwiczenie na tym przyrządzie kształtuje pośladki, mięśnie ud i łydek.  
Wymiary ( dł x szer x wys): 270 x 20 x 60 cm  
Strefa bezpieczeństwa (dł x szer): 570x 320 cm  
KOD PRODUKTU: SZ001-5

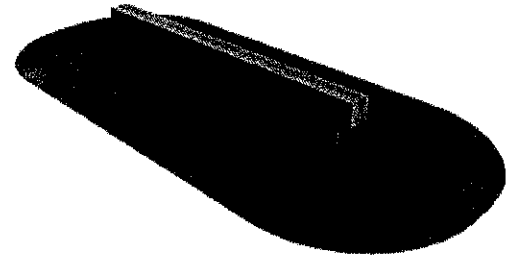

**STRAHL FÜR AUSFLÜGE AN DIE FRONT**

Übung auf diesem Gerät formt das Gesäß, Oberschenkel und Waden.  
Größe (Länge x Breite x Höhe): 270 x 20 x 60 cm  
Sicherheitszone (Länge x Breite): 570x 320 cm  
PRODUKT-CODE: SZ001-5

**BEAM FOR TRIPS TO THE FRONT**

Exercise on this device shapes the buttocks, thighs and calves.  
Dimension ( length x width x height): 270 x 20 x 60 cm  
Safety zone (length x width): 570x 320 cm  
PRODUCT CODE: SZ001-5

Cena netto:  
6000,00 zł  
Cena brutto:  
7380,00 zł

**DRABINKA**  
Urządzenie ogólnorozwojowe, wzmacnia mięśnie kończyn górnych oraz pleców.  
Wymiary ( dł x szer x wys): 300 x 100 x 250 cm  
Strefa bezpieczeństwa (dł x szer): 732 x 532 cm  
KOD PRODUKTU: SZ001-6

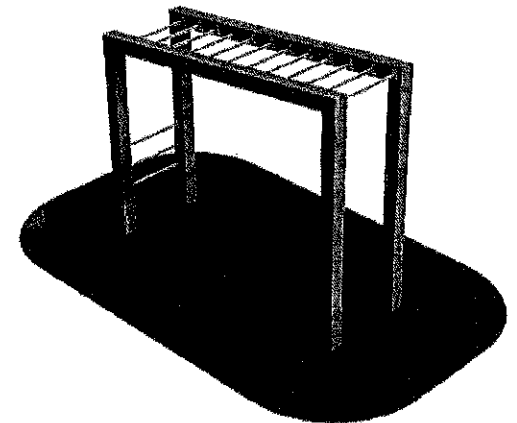

**LEITER**

Die Einheit allgemeine Entwicklung, stärkt die Muskeln der oberen Extremitäten und Rücken.  
Größe (Länge x Breite x Höhe): 300 x 100 x 250cm  
Sicherheitszone (Länge x Breite): 732 x 532 cm  
PRODUKT-CODE: SZ001-6

**LADDER**

The device general development, strengthens the muscles of the upper limbs and back.  
Dimension ( length x width x height): 300 x 100 x 250cm  
Safety zone (length x width): 732 x 532 cm  
PRODUCT CODE: SZ001-6

Cena netto:  
6000,00 zł  
Cena brutto:  
7380,00 zł

**DRAŻKI + KOŁA GIMNASTYCZNE**

Urządzenie wzmacnia mięśnie pleców oraz ramion.  
Wymiary ( dł x szer x wys): 200x 200 x 310 cm  
Strefa bezpieczeństwa (dł x szer): 732 x 532 cm  
KOD PRODUKTU: SZ001-6

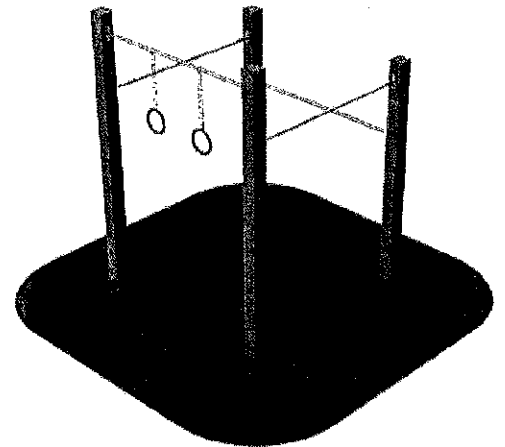

**LEITER**

Gerät stärkt die Rückenmuskulatur und Schultern.  
Größe (Länge x Breite x Höhe): 300 x 100 x 250cm  
Sicherheitszone (Länge x Breite): 712 x 712 cm  
PRODUKT-CODE: SZ001-8

**LADDER**

The device general development, strengthens the muscles of the upper limbs and back.  
Dimension ( length x width x height): 300 x 100 x 250cm  
Safety zone (length x width): 712 x 712 cm  
PRODUCT CODE: SZ001-8

Cena netto:  
2300,00 zł  
Cena brutto:  
2829,00 zł

**ŻMIJKA NA SŁUPACH DREWNIANYCH**

Urządzenie to wpływa na mięśnie ramion oraz pleców.  
Wymiary ( dł x szer x wys): 200x 60 x 250 cm  
Strefa bezpieczeństwa (dł x szer): 566 x 426 cm  
KOD PRODUKTU: SZ001-13

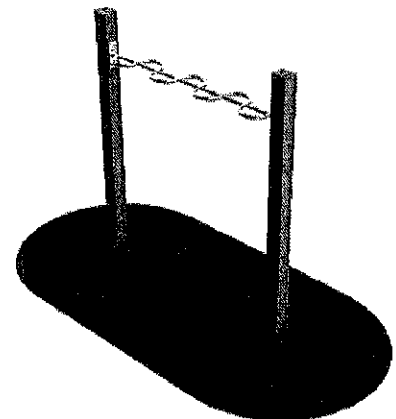

**DIE SCHLANGE HOLZMASTEN**

Dieses Gerät wirkt sich auf die Muskeln der Arme und Rücken.  
Größe (Länge x Breite x Höhe): 200x 60 x 250 cm  
Sicherheitszone (Länge x Breite): 566 x 426 cm  
PRODUKT-CODE: SZ001-13

**THE SNAKE WOODEN POLES**

This device affects the muscles of the arms and back.  
Dimension ( length x width x height): 200x 60 x 250 cm  
Safety zone (length x width): 566 x 426 cm  
PRODUCT CODE: SZ001-13

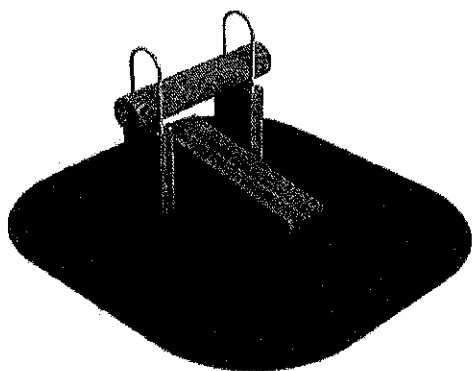
**WYCISKANIE BELKI**

urządzenie to wpływa na mięśnie klatki piersiowej, ramion i barków.

Wymiary( dł x szer x wys): 140 x 140 x 130 cm

Strefa bezpieczeństwa (dł x szer): 440 x 440 cm

KOD PRODUKTU: SZ001-12

Cena netto:  
6000,00 zł  
Cena brutto:  
7380,00 zł

**SQUEEZING BEAM**

This device affects the muscles of the chest, arms and shoulders.

Dimension ( length x width x height): 140 x 140 x 130 cm

Safety zone (length x width): 440 x 440 cm

PRODUCT CODE: SZ001-12

**QUTESCHEN STRAHL**

Das Gerät wirkt sich auf die Muskeln der Brust, Arme und Schultern.

Größe (Länge x Breite x Höhe): 140 x 140 x 130 cm

Sicherheitszone (Länge x Breite): 440 x 440 cm

PRODUKT-CODE: SZ001-12

**POMPKI**

Urządzenie wpływa na budowę mięśni klatki piersiowej, barków, ramion i mięśni tułowia.

Wymiary( dł x szer x wys): 380 x 230 x 70 cm

Strefa bezpieczeństwa (dł x szer): 680 x 530 cm

KOD PRODUKTU: SZ001-3

Cena netto:  
5500,00 zł  
Cena brutto:  
6765,00 zł

**PUMPS**

The device affects the construction of the muscles of the chest, shoulders, arms and trunk muscles.

Dimension ( length x width x height): 380 x 230 x 70 cm

Safety zone (length x width): 680 x 530 cm

PRODUCT CODE: SZ001-3

**PUMPS**

Das Gerät wirkt sich auf den Aufbau der Muskeln der Brust, Schultern, Arme und Rumpfmuskulatur.

Größe (Länge x Breite x Höhe): 380 x 230 x 70 cm

Sicherheitszone (Länge x Breite): 680 x 530 cm

PRODUKT-CODE: SZ001-3

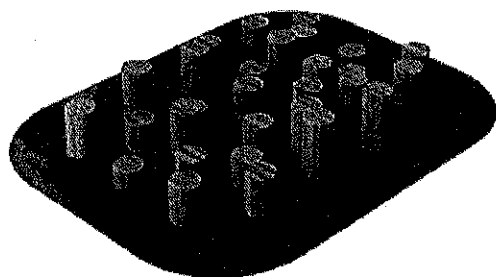
**PIEŃKI**

Urządzenie to idealnie nadaje się do treningu równowagi.

Wymiary( dł x szer x wys): 450 x 300 x 60 cm

Strefa bezpieczeństwa (dł x szer): 750 x 600 cm

KOD PRODUKTU: SZ001-9

Cena netto:  
5400,00 zł  
Cena brutto:  
6642,00 zł

**STUMPS**

This device is ideal for balance training.

Dimension ( length x width x height): 450 x 300 x 60 cm

Safety zone (length x width): 750 x 600 cm

PRODUCT CODE: SZ001-9

**HÜRDENLAUF**

Dieses Gerät ist ideal für Balancetraining.

Größe (Länge x Breite x Höhe): 450 x 300 x 60 cm

Sicherheitszone (Länge x Breite): 750 x 600 cm

PRODUKT-CODE: SZ001-9

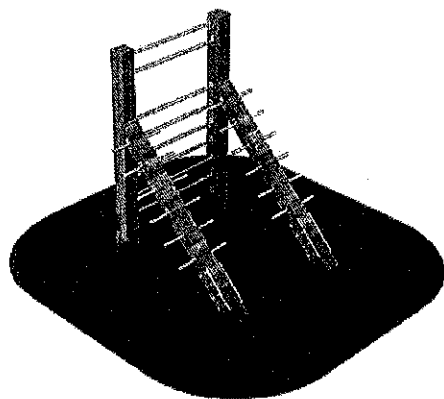
**DRABINKA KRZYŻAKOWA**

Urządzenie ogólnorozwojowe, wzmacnia mięśnie kończyn górnych, dolnych oraz pleców.

Wymiary( dł x szer x wys): 150 x 150 x 200 cm

Strefa bezpieczeństwa (dł x szer): 516 x 516 cm

KOD PRODUKTU: SZ001-7

Cena netto:  
6500,00 zł  
Cena brutto:  
7995,00 zł

**CROSS LADDER**

The device general development, strengthens the muscles of the upper and lower limbs and back.

Dimension ( length x width x height): 150 x 150 x 200 cm

Safety zone (length x width): 516 x 516 cm

PRODUCT CODE: SZ001-7

**KREUZ-LEITER**

Die Einheit allgemeine Entwicklung, stärkt die Muskeln der oberen und unteren Extremitäten und Rücken.

Größe (Länge x Breite x Höhe): 150 x 150 x 200 cm

Sicherheitszone (Länge x Breite): 516 x 516 cm

PRODUKT-CODE: SZ001-7

pl

Drewno pozyskiwane do naszych przyrządów posiada certyfikat FSC (Forest Stewardship Council). Pochodzi z kontrolowanych upraw, prowadzonych zgodnie ze światowym programem ochrony lasów.

eng

The wood for our instruments is FSC certified (Forest Stewardship Council) - it comes from controlled cultivation, carried out in accordance with the global forests protection program.

de

Das Holz ist FSC-zertifiziert (Forest Stewardship Council) - stammt aus kontrolliertem Anbau, in Übereinstimmung mit der globalen Wälder Schutzprogramm durchgeführt.



mała  
architektura

Street furniture / Stadtmöbel

**Cena netto:**  
3500,00 zł  
**Cena brutto:**  
4305,00 zł

**STÓŁ DO GRY W TENISA HUSE**

Wymiary: 274 x 152 x 76 cm  
Strefa bezpieczeństwa (dł x szer):  
KOD PRODUKTU: TEL060-1

**TABLE TENNIS GAME HUSE**

Dimension: 274 x 152 x 76 cm  
Safety zone (length x width):  
PRODUCT CODE: TEL060-1

**Tischtennis -Spiel HUSE**

Größe: 274 x 152 x 76 cm  
Sicherheitszone (Länge x Breite):  
PRODUKT-CODE: TEL060-1

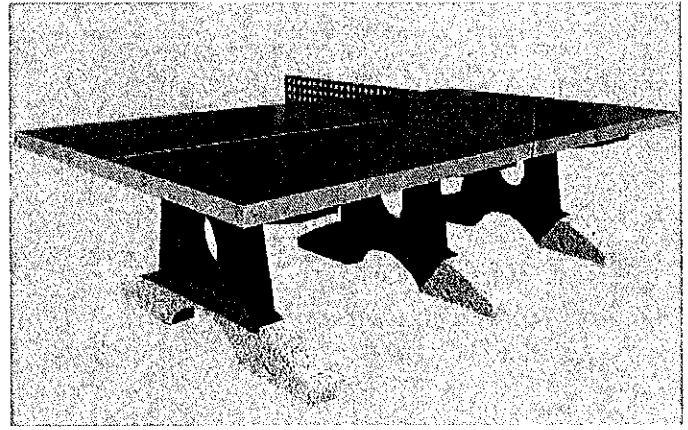

**Cena netto:**  
4600,00 zł  
**Cena brutto:**  
5658,00 zł

**STÓŁ DO GRY W PIŁKARZYKI HUSE**

Wymiary: 140 x 80 x 87 cm  
Strefa bezpieczeństwa (dł x szer):  
KOD PRODUKTU: TEL060-2

**TABLE FOOTBALL GAME HUSE**

Dimension: 140 x 80 x 87 cm  
Safety zone (length x width):  
PRODUCT CODE: TEL060-3

**TISCHFUSSBALLSPIEL HUSE**

Größe: 140 x 80 x 87 cm  
Sicherheitszone (Länge x Breite):  
PRODUKT-CODE: TEL060-3

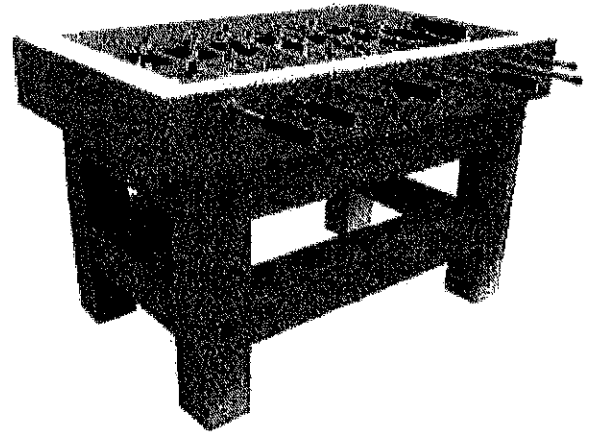

**Cena netto:**  
2900,00 zł  
**Cena brutto:**  
3567,00 zł

**STÓŁ DO GRY W SZACHY  
I CHIŃCZYKA HUSE**

Wymiary: 160 x 160 x 76 cm  
Strefa bezpieczeństwa (dł x szer):  
KOD PRODUKTU: TEL060-2

**CHESSTABLE/LUDO TABLE HUSE**

Dimension: 160 x 160 x 76 cm  
Safety zone (length x width):  
PRODUCT CODE: TEL060-2

**SCHACHTISCH/TISCH LUDO HUSE**

Größe: 160 x 160 x 76 cm  
Sicherheitszone (Länge x Breite):  
PRODUKT-CODE: TEL060-2

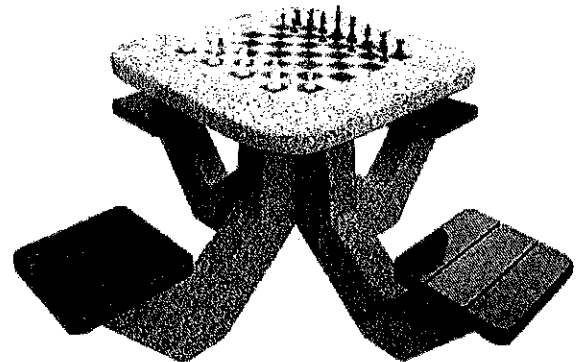

**Cena netto:**  
450,00 zł  
**Cena brutto:**  
553,50 zł

**KOSZ HUSE I**

Wymiary: 95 x 43 cm  
Strefa bezpieczeństwa (dł x szer):  
KOD PRODUKTU: TEL080-1

**BASKET HUSE I**

Dimension: 95 x 43 cm  
Safety zone (length x width):  
PRODUCT CODE: TEL080-1

**BASKET HUSE I**

Größe: 95 x 43 cm  
Sicherheitszone (Länge x Breite):  
PRODUKT-CODE: TEL080-1

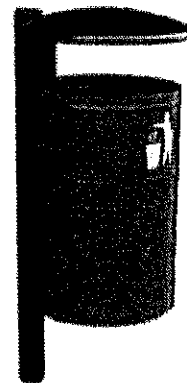

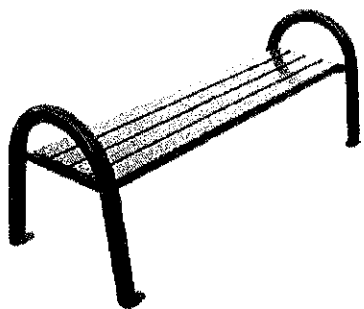
**ŁAWKA HUSE I**

Wymiary (dł x szer x wys) 170 x 62 x 60 cm

Strefa bezpieczeństwa (dł x szer):

KOD PRODUKTU: TEL060-1

Cena netto:

650,00 zł

Cena brutto:

799,50 zł

**BENCH HUSE I**

Dimension (length x width x height): 170 x 62 x 60 cm

Safety zone (length x width):

PRODUCT CODE: TEL060-1

**BANK HUSE I**

Größe (Länge x Breite x Höhe): 170 x 62 x 60 cm

Sicherheitszone (Länge x Breite):

PRODUKT-CODE: TEL060-1

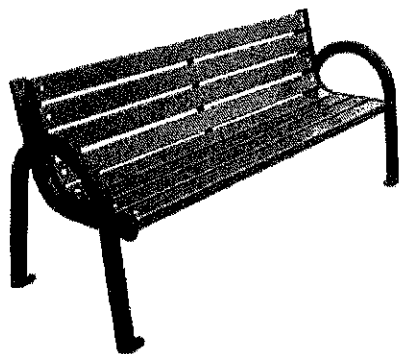
**ŁAWKA HUSE II**

Wymiary (dł x szer x wys) 180 x 65 x 77 cm

Strefa bezpieczeństwa (dł x szer):

KOD PRODUKTU: TEL070-2

Cena netto:

800,00 zł

Cena brutto:

984,00 zł

**BENCH HUSE II**

Dimension (length x width x height): 180 x 65 x 77 cm

Safety zone (length x width):

PRODUCT CODE: TEL070-2

**BANK HUSE II**

Größe (Länge x Breite x Höhe): 180 x 65 x 77 cm

Sicherheitszone (Länge x Breite):

PRODUKT-CODE: TEL070-2

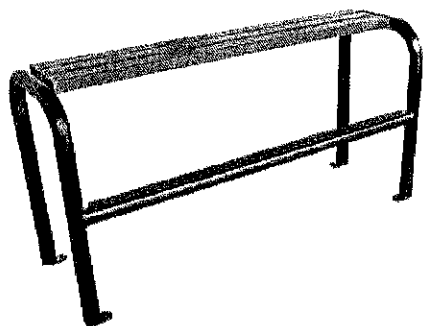
**ŁAWKA HUSE VI**

Wymiary (dł x szer x wys) 170 x 55 x 85 cm

Strefa bezpieczeństwa (dł x szer):

KOD PRODUKTU: TEL070-6

Cena netto:

750,00 zł

Cena brutto:

922,50 zł

**BENCH HUSE VI**

Dimension (length x width x height): 170 x 55 x 85 cm

Safety zone (length x width):

PRODUCT CODE: TEL070-6

**BANK HUSE VI**

Größe (Länge x Breite x Höhe): 170 x 55 x 85 cm

Sicherheitszone (Länge x Breite):

PRODUKT-CODE: TEL070-6

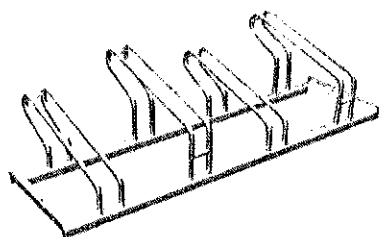
**STOJAK NA ROWER HUSE 4**

Wymiary (dł x szer x wys) 136 x 54 x 40 cm

Strefa bezpieczeństwa (dł x szer):

KOD PRODUKTU: TEL090-1

Cena netto:

500,00 zł

Cena brutto:

615,00 zł

**BIKE RACK HUSE 4**

Dimension (length x width x height): 136 x 54 x 40 cm

Safety zone (length x width):

PRODUCT CODE: TEL090-1

**STAND FÜR FAHRRAD HUSE 4**

Größe (Länge x Breite x Höhe): 136 x 54 x 40 cm

Sicherheitszone (Länge x Breite):

PRODUKT-CODE: TEL090-1

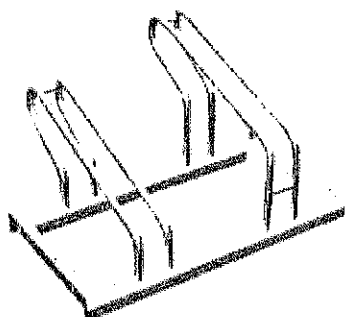
**STOJAK NA ROWER HUSE 2**

Wymiary (dł x szer x wys) 68 x 54 x 40 cm

Strefa bezpieczeństwa (dł x szer):

KOD PRODUKTU: TEL090-4

Cena netto:

350,00 zł

Cena brutto:

430,50 zł

**BIKE RACK HUSE 2**

Dimension (length x width x height): 68 x 54 x 40 cm

Safety zone (length x width):

PRODUCT CODE: TEL090-4

**STAND FÜR FAHRRAD HUSE 2**

Größe (Länge x Breite x Höhe): 68 x 54 x 40 cm

Sicherheitszone (Länge x Breite):

PRODUKT-CODE: TEL090-4





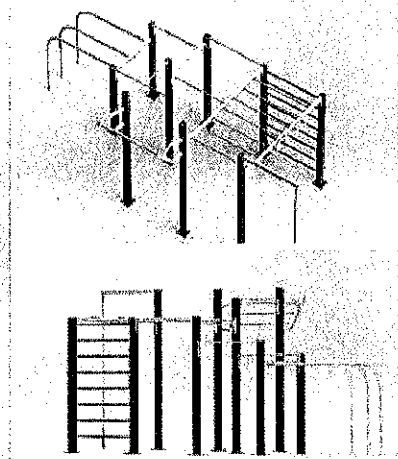
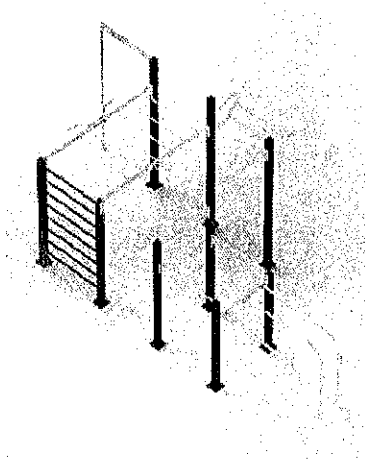

street  
workout

**BRAMA CROSSFIT Z POLE DANCE**

Wymiary (dł x szer x wys): 640 x 250 x 270 cm

Strefa bezpieczeństwa (dł x szer):

KOD PRODUKTU: CF001

Cena netto:

11000,00 zł

Cena brutto:

13530,00 zł

**CROSSFIT GATE OF THE POLE DANCE**

Dimension ( length x width x height): 640 x 250 x 270 cm

Safety zone (length x width):

PRODUCT CODE: CF001

**CROSSFIT TOR DER POLE DANCE**

Größe (Länge x Breite x Höhe):: 640 x 250 x 270 cm

Sicherheitszone (Länge xBreite):

PRODUKT-CODE: CF001

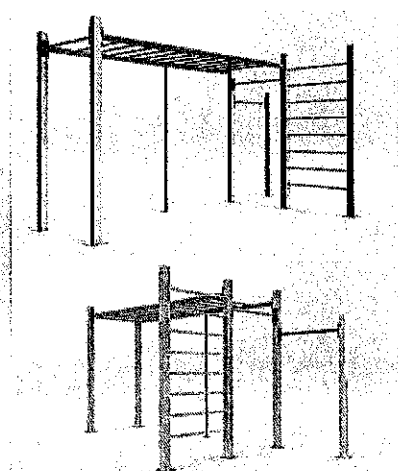
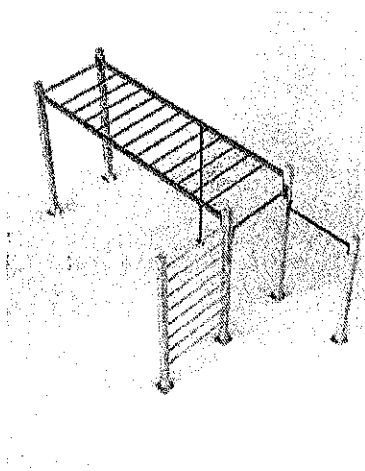
**STREET WORKOUT DRABINKI**

Wymiary (dł x szer x wys): 207 x 250 x 250 cm

Strefa bezpieczeństwa (dł x szer): 641 x 684 cm

KOD PRODUKTU: SW002

Cena netto:

6500,00 zł

Cena brutto:

7995,00 zł

**STREET WORKOUT LADDERS**

Dimension ( length x width x height): 207 x 250 x 250 cm

Safety zone (length x width): 641 x 684 cm

PRODUCT CODE: SW002

**STREET WORKOUT LEITERN**

Größe (Länge x Breite x Höhe):: 207 x 250 x 250 cm

Sicherheitszone (Länge xBreite): 641 x 684 cm

PRODUKT-CODE: SW002

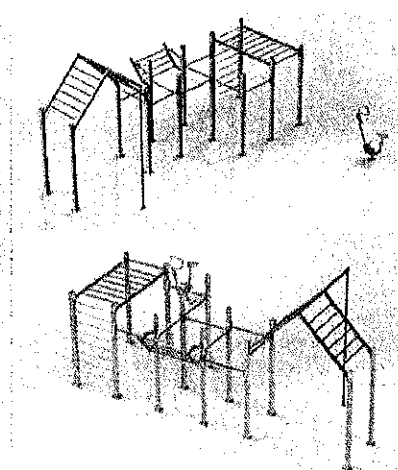
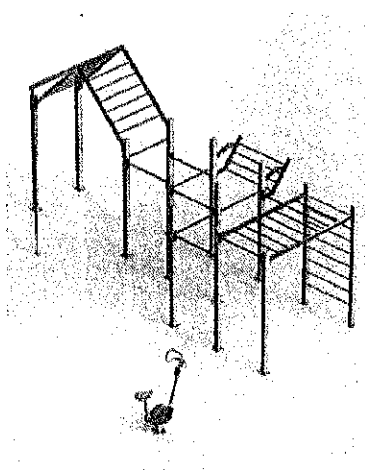
**STREET WORKOUT + ROWER Z ŁADOWARKĄ USB**

Wymiary (dł x szer x wys): 744 x 322 x 360 cm

Strefa bezpieczeństwa (dł x szer): 1324 x 902 cm

KOD PRODUKTU: SW003

Cena netto:

24000,00 zł

Cena brutto:

29520,00 zł

**STREET WORKOUT + BIKE WITH USB CHARGER**

Dimension ( length x width x height) : 744 x 322 x 360 cm

Safety zone (length x width): 1324 x 902 cm

PRODUCT CODE: SW003

**STREET WORKOUT + FAHRRAD MIT USB-LADEGERÄT**

Größe (Länge x Breite x Höhe):: 744 x 322 x 360 cm

Sicherheitszone (Länge xBreite): 1324 x 902 cm

PRODUKT-CODE: SW003

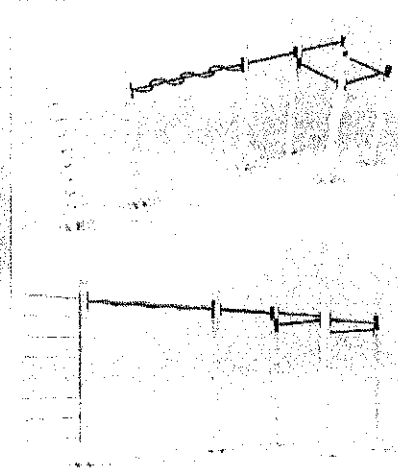
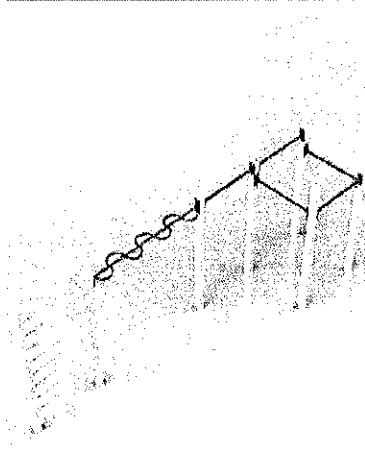
**STREET WORKOUT ZE ŻMIJKĄ**

Wymiary (dł x szer x wys): 577 x 135 x 250 cm

Strefa bezpieczeństwa (dł x szer): 1011 x 569 cm

KOD PRODUKTU: SW004

Cena netto:

6500,00 zł

Cena brutto:

7995,00 zł

**STREET WORKOUT WITH SNAKE**

Dimension ( length x width x height): 577 x 135 x 250 cm

Safety zone (length x width): 1011 x 569 cm

PRODUCT CODE: SW004

**STREET WORKOUT MIT SCHLANGE**

Größe (Länge x Breite x Höhe):: 577 x 135 x 250 cm

Sicherheitszone (Länge xBreite): 1011 x 569 cm

PRODUKT-CODE: SW004

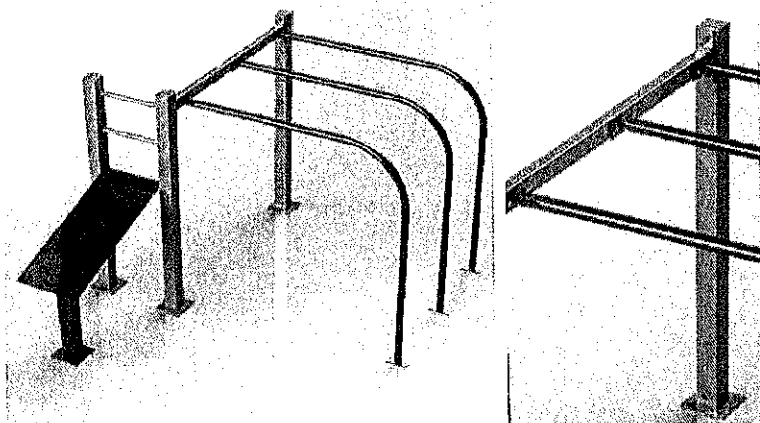
**ŁAWECZKA Z PORĘCZAMI**

Wymiary (dł x szer x wys): 289 x 236 x 160 cm

Strefa bezpieczeństwa (dł x szer): 603 x 550 cm

KOD PRODUKTU: SW008

Cena netto:

4200,00 zł

Cena brutto:

5166,00 zł

**BENCH WITH HANDRAILS**

Dimension (length x width x height): 289 x 236 x 160 cm

Safety zone (length x width): 603 x 550 cm

PRODUCT CODE: SW008

**BANK MIT HANDLÄUFEN**

Größe (Länge x Breite x Höhe): 289 x 236 x 160 cm

Sicherheitszone (Länge x Breite): 603 x 550 cm

PRODUKT-CODE: SW008

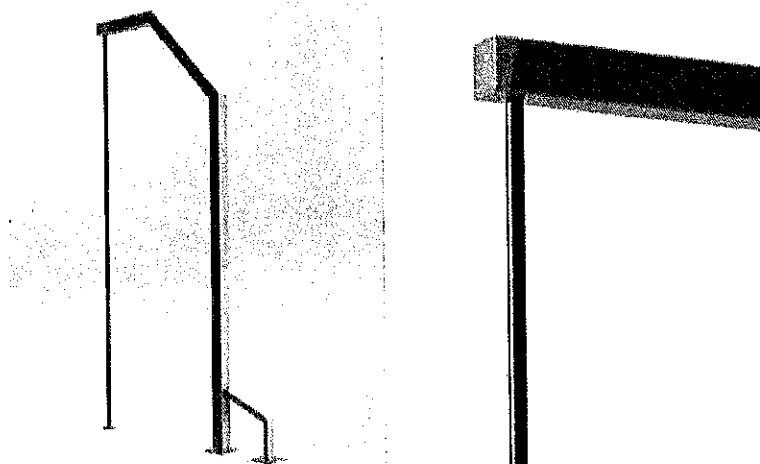
**POLE DANCE / ROPE**

Wymiary (dł x szer x wys): 200 x 10 x 360 cm

Strefa bezpieczeństwa (dł x szer): 780 x 590 cm

KOD PRODUKTU: SW005

Cena netto:

1700,00 zł

Cena brutto:

2091,00 zł

**POLE DANCE / ROPE**

Dimension (length x width x height): 200 x 10 x 360 cm

Safety zone (length x width): 780 x 590 cm

PRODUCT CODE: SW005

**POLE DANCE / BAUM**

Größe (Länge x Breite x Höhe): 200 x 10 x 360 cm

Sicherheitszone (Länge x Breite): 780 x 590 cm

PRODUKT-CODE: SW005

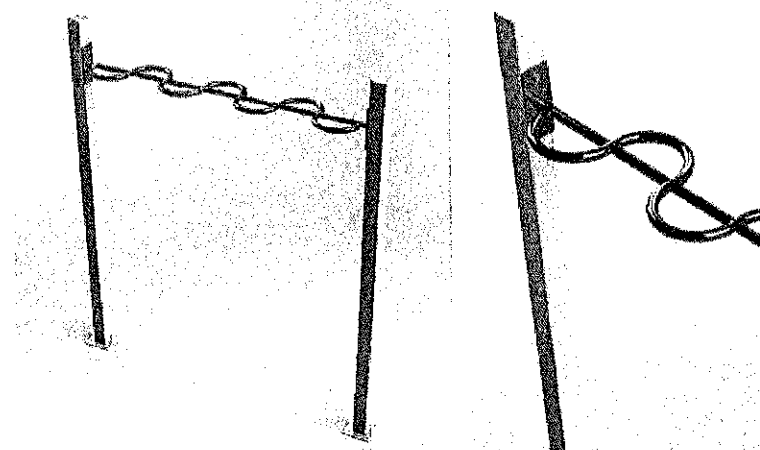
**ŻMIJKA**

Wymiary (dł x szer x wys): 220 x 33 x 250 cm

Strefa bezpieczeństwa (dł x szer): 654 x 467 cm

KOD PRODUKTU: SW006

Cena netto:

2100,00 zł

Cena brutto:

2583,00 zł

**SNAKE**

Dimension (length x width x height): 220 x 33 x 250 cm

Safety zone (length x width): 654 x 467 cm

PRODUCT CODE: SW006

**SCHLANGE**

Größe (Länge x Breite x Höhe): 220 x 33 x 250 cm

Sicherheitszone (Länge x Breite): 654 x 467 cm

PRODUKT-CODE: SW006

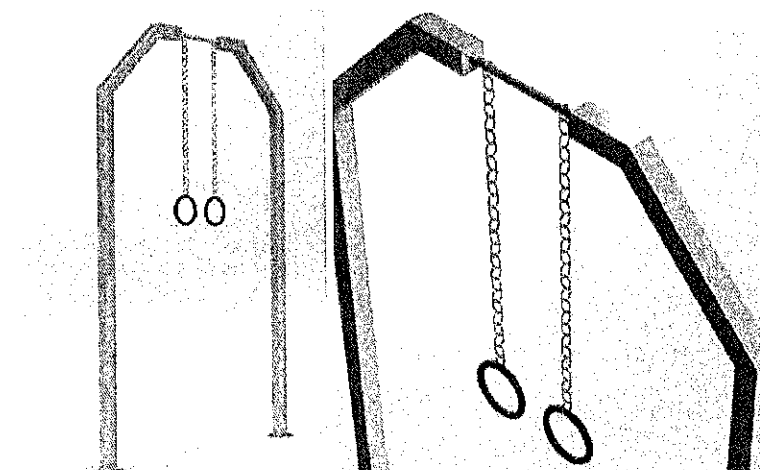
**KOLA**

Wymiary (dł x szer x wys): 220 x 10 x 360 cm

Strefa bezpieczeństwa (dł x szer): 800 x 590 cm

KOD PRODUKTU: SW007

Cena netto:

2650,00 zł

Cena brutto:

3259,50 zł

**WHEELS**

Dimension (length x width x height): 220 x 10 x 360 cm

Safety zone (length x width): 800 x 590 cm

PRODUCT CODE: SW007

**RÄDER**

Größe (Länge x Breite x Höhe): 220 x 10 x 360 cm

Sicherheitszone (Länge x Breite): 800 x 590 cm

PRODUKT-CODE: SW007

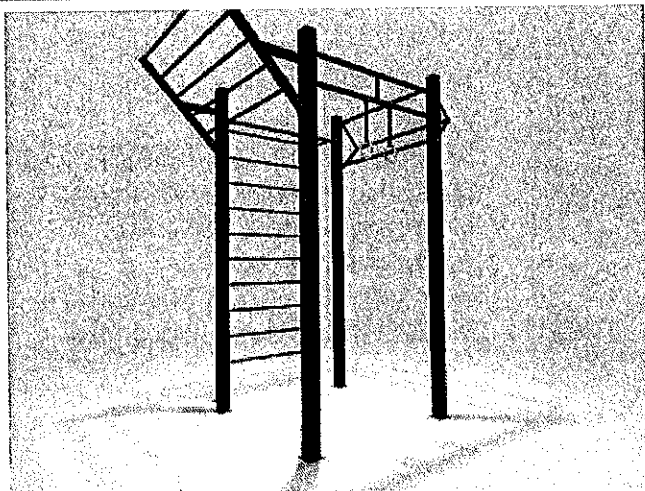

Bramy  
Crossfit  
Crossfit Racks

**MODUŁ DRABINKA**

Wymiary (dł x szer x wys): 1455 x 1645 x 2345 mm  
 Strefa bezpieczeństwa (dł x szer): 4455 x 4645 mm  
 KOD PRODUKTU: CR001

Cena netto:  
2000,00 zł  
 Cena brutto:  
2460,00 zł

**MODULLEITER**

Größe (Länge x Breite x Höhe): 1455 x 1645 x 2345 mm  
 Sicherheitszone (Länge x Breite): 4455 x 4645 mm  
 PRODUKT-CODE: CR001

**MODULE LADDER**

Dimension ( length x width x height): 1455 x 1645 x 2345 mm  
 Safety zone (length x width): 4455 x 4645 mm  
 PRODUCT CODE: CR001

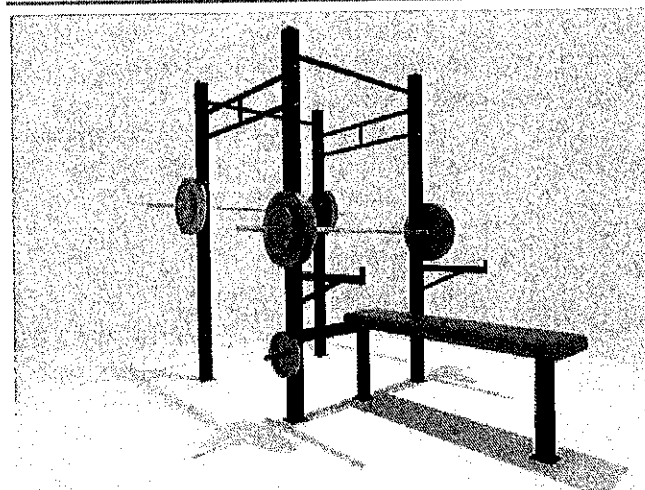
**MODUŁ SZTANGA**

Wymiary (dł x szer x wys): 2370 x 1450 x 2100 mm  
 Strefa bezpieczeństwa (dł x szer): 5370 x 3450 mm  
 KOD PRODUKTU: CR002

Cena netto:  
2000,00 zł  
 Cena brutto:  
2460,00 zł

**MODUL BARBELL**

Größe (Länge x Breite x Höhe): 2370 x 1450 x 2100 mm  
 Sicherheitszone (Länge x Breite): 5370 x 3450 mm  
 PRODUKT-CODE: CR002

**MODULE BARBELL**

Dimension ( length x width x height): 2370 x 1450 x 2100 mm  
 Safety zone (length x width): 5370 x 3450 mm  
 PRODUCT CODE: CR002

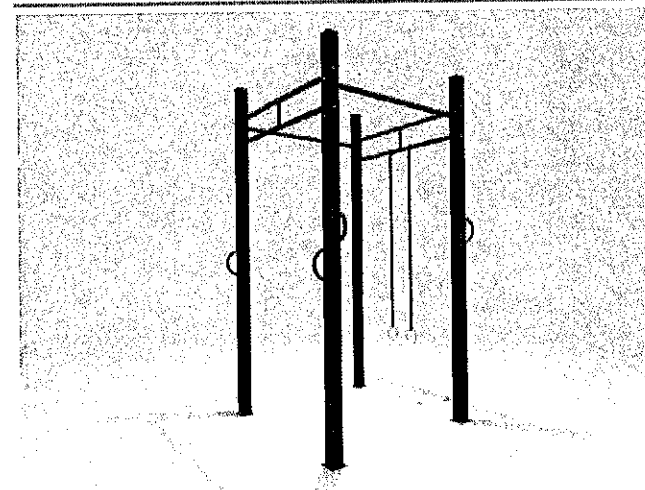
**MODUŁ TRX**

Wymiary (dł x szer x wys): 1240 x 1240 x 2300 mm  
 Strefa bezpieczeństwa (dł x szer): 4240 x 4240 mm  
 KOD PRODUKTU: CR003

Cena netto:  
2000,00 zł  
 Cena brutto:  
2460,00 zł

**MODUL TRX**

Größe (Länge x Breite x Höhe): 1240 x 1240 x 2300 mm  
 Sicherheitszone (Länge x Breite): 603 x 550 cm  
 PRODUKT-CODE: CR003

**MODULE TRX**

Dimension ( length x width x height): 1240 x 1240 x 2300 mm  
 Safety zone (length x width): 4240 x 4240 mm  
 PRODUCT CODE: CR003

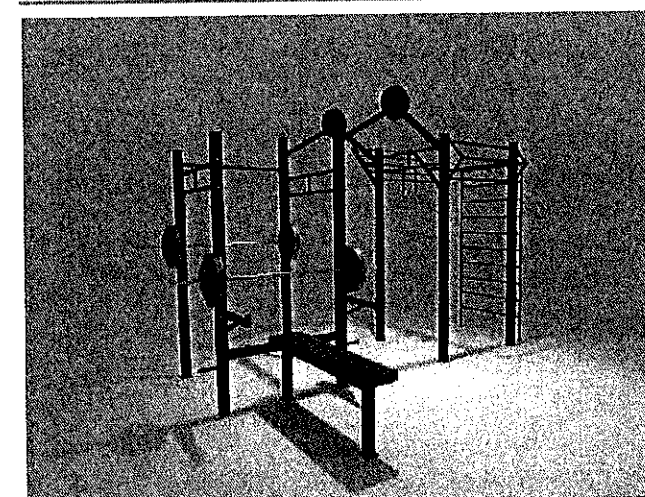
**MODUŁ PODWÓJNY**

Wymiary (dł x szer x wys): 3727 x 3924 x 2345 mm  
 Strefa bezpieczeństwa (dł x szer): 6455 x 6645 mm  
 KOD PRODUKTU: CR004

Cena netto:  
5500 zł  
 Cena brutto:  
6765 zł

**DOPPELMODUL**

Größe (Länge x Breite x Höhe): 3727 x 3924 x 2345 mm  
 Sicherheitszone (Länge x Breite): 6455 x 6645 mm  
 PRODUKT-CODE: CR004

**DOUBLE MODULE**

Dimension ( length x width x height): 3727 x 3924 x 2345 mm  
 Safety zone (length x width): 6455 x 6645 mm  
 PRODUCT CODE: CR004

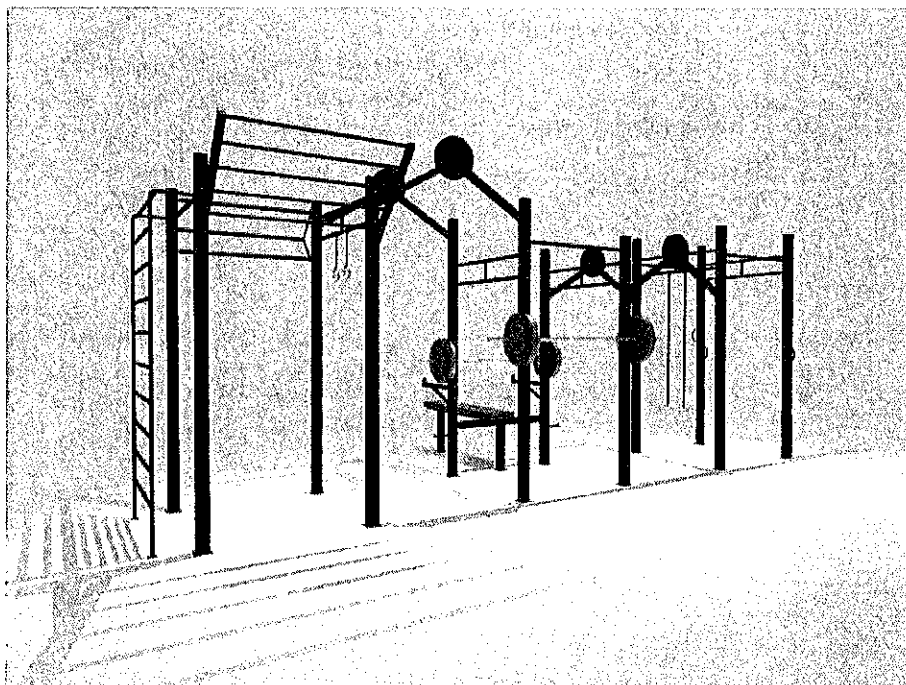

### MODUŁ POTRÓJNY

Połączone ze sobą trzy moduły - "DRABINKA" (CR001), "SZTANGA" (CR002) i "TRX" (CR003), na które składa się szesnaście stanowisk do ćwiczeń. Pomędzy nimi cztery dodatkowe stanowiska do podrzutów piłką lekarską.

Wymiary (dł x szer x wys): 1240 x 1240 x 2300 mm  
Strefa bezpieczeństwa (dł x szer): 4240 x 4240 mm  
KOD PRODUKTU: CR005

### TRIPLE MODULE

Three modules joined together - "LADDER" (CR001), "BARBELL" (CR002) and "TRX" (CR003) which consists of sixteen positions to exercise. Between them, the four additional posts for medicine ball tosses.

Größe (Länge x Breite x Höhe): 1240 x 1240 x 2300 mm  
Sicherheitszone (Länge x Breite): 4240 x 4240 mm  
PRODUKT-CODE: CR005

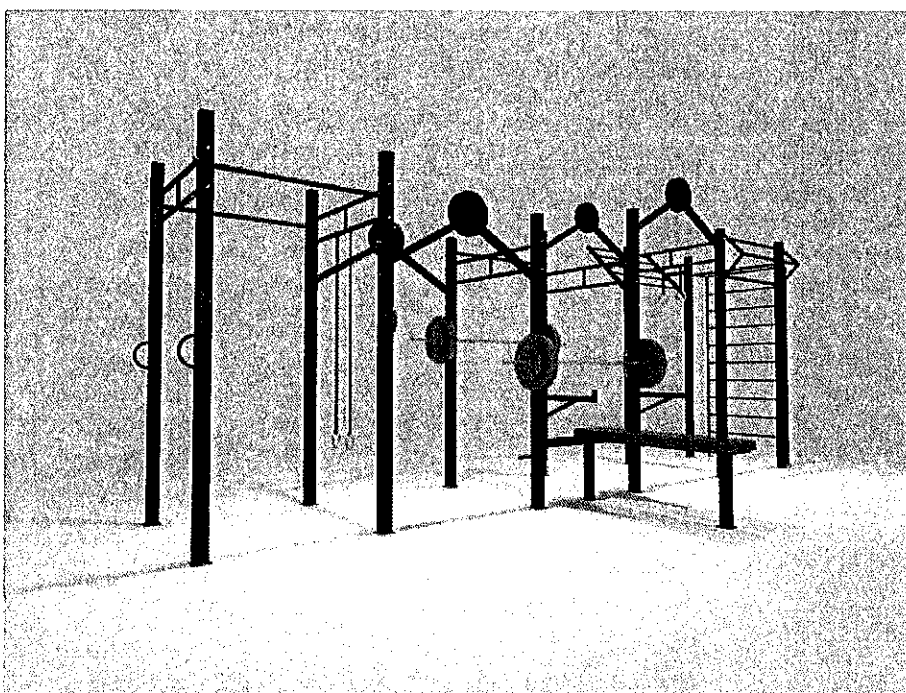

### DREIERMODUL

Drei Module miteinander verbunden - "LADDER" (CR001), "BARBELL" (CR002) und "TRX" (CR003) Die aus sechzehn Positionen besteht, um auszuüben. Zwischen ihnen die vier zusätzlichen Stellen für Medizinball wirft.

Dimension ( length x width x height): 1240 x 1240 x 2300 mm  
Safety zone (length x width): 4240 x 4240 mm  
PRODUCT CODE: CR005

Cena netto:  
9000,00 zł  
Cena brutto:  
11070 zł

### PODSTAWOWA KOLORYSTYKA BRAM CROSSFIT:

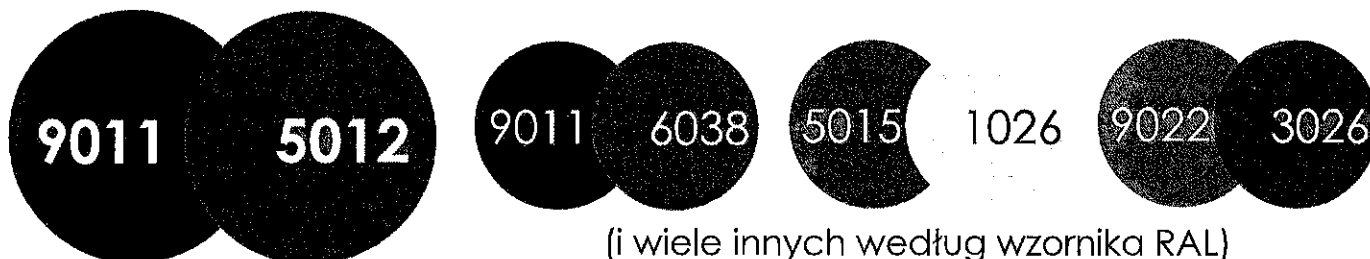

(i wiele innych według wzornika RAL)



multi  
siłownie

Multigyms / Multigymen

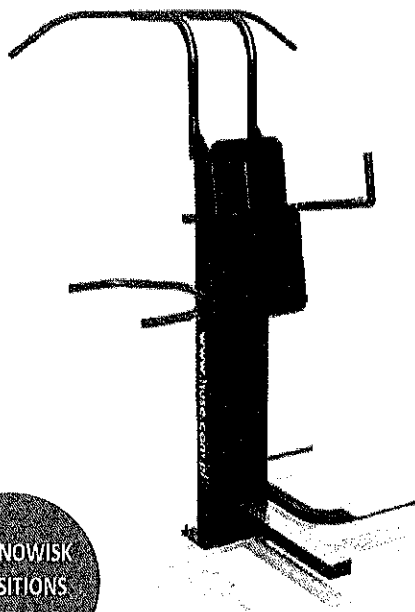

5 STANOWISK  
5 POSITIONS  
5 POSITIONEN

### COMBO I

Jest to urządzenie wielofunkcyjne umożliwiające ćwiczenie mięśni grzbietu, brzucha, kończyn dolnych oraz ramion.

Wymiary (dł x szer x wys): 1455 x 1645 x 2345 mm  
Strefa bezpieczeństwa (dł x szer): 4455 x 4645 mm  
KOD PRODUKTU: CR001

Cena netto:  
4900,00 zł  
Cena brutto:  
6027,00 zł

### COMBO I

Es ist ein multifunktionales Gerät, das die Muskeln von Rücken, Bauch, Beinen und Armen ausübt.

Größe (Länge x Breite x Höhe): 1455 x 1645 x 2345 mm  
Sicherheitszone (Länge x Breite): 4455 x 4645 mm  
PRODUKT-CODE: CR001

9022  
9011  
7040

### COMBO I

It is multifunctional device which allows exercise the muscles of the back, abdomen, legs and arms.

Dimensions ( length x width x height): 1455 x 1645 x 2345 mm  
Safety zone (length x width): 4455 x 4645 mm  
PRODUCT CODE: CR001

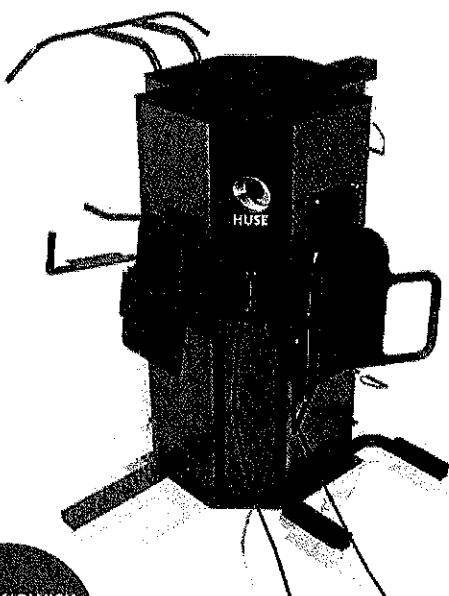

11 STANOWISK  
11 POSITIONS  
11 POSITIONEN

### COMBO II

Jest to urządzenie wielofunkcyjne umożliwiające ćwiczenie mięśni grzbietu, brzucha, kończyn dolnych oraz ramion.

Wymiary (dł x szer x wys): 1455 x 1645 x 2345 mm  
Strefa bezpieczeństwa (dł x szer): 4455 x 4645 mm  
KOD PRODUKTU: CR001

Cena netto:  
32000,00 zł  
Cena brutto:  
39360,00 zł

### COMBO II

Es ist ein multifunktionales Gerät, das die Muskeln von Rücken, Bauch, Beinen und Armen ausübt.

Größe (Länge x Breite x Höhe): 1455 x 1645 x 2345 mm  
Sicherheitszone (Länge x Breite): 4455 x 4645 mm  
PRODUKT-CODE: CR001

### COMBO II

It is multifunctional device which allows exercise the muscles of the back, abdomen, legs and arms.

Dimensions ( length x width x height): 1455 x 1645 x 2345 mm  
Safety zone (length x width): 4455 x 4645 mm  
PRODUCT CODE: CR001

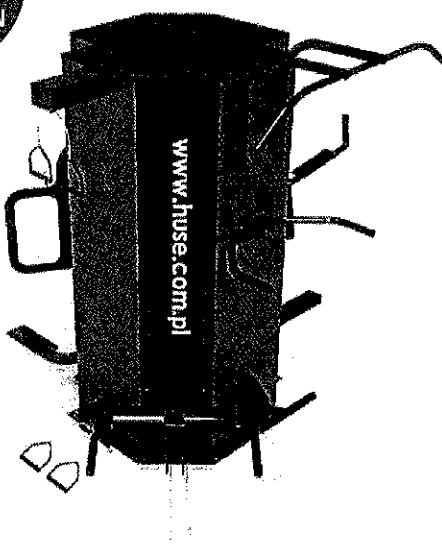

9011 5012 9011 6038 5012 7040 6038 7040





hard work  
good direction  
a clear purpose

FHU HUSE Sebastian Hulbój  
Bielsko-Biała 43-300  
ul. Pierkarska 80  
POLAND

tel.: +48 600 269 537, 793 803 160  
e-mail: [biuro@huse.com.pl](mailto:biuro@huse.com.pl)

[www.facebook.com/Huseft43](http://www.facebook.com/Huseft43)

[www.huse.com.pl](http://www.huse.com.pl)

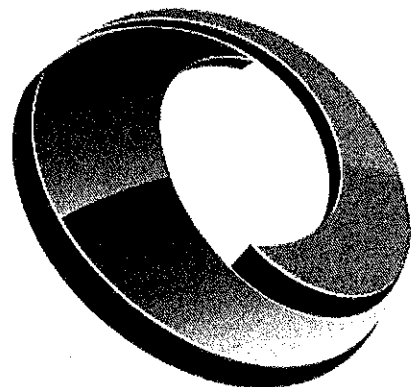

**HUSE**

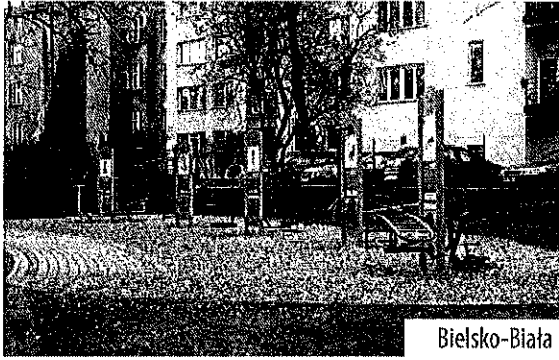

Bielsko-Biala



Żory



Bielsko-Biala

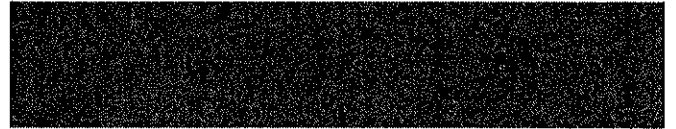

Hańców



Bielsko-Biala

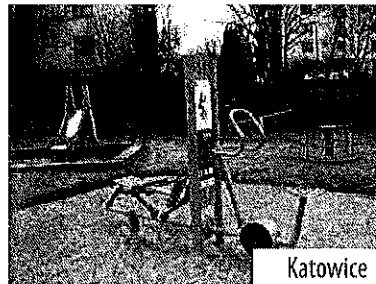
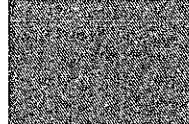

Katowice

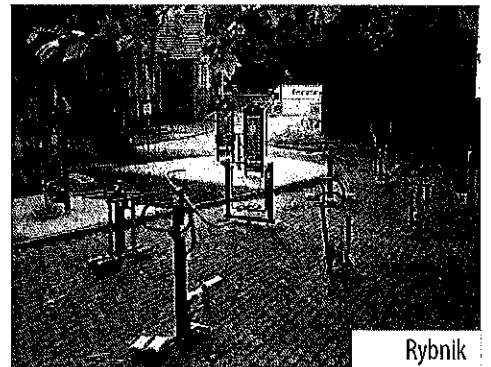

Rybnik

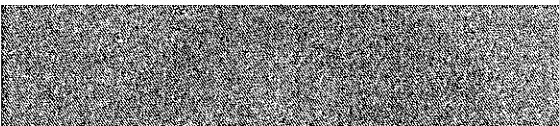

Katowice



Gmina Godów



Siemianowice



Gmina Godów



# Seria FIT PRO

Plan fundamentowania

Footing plan

Pylon/Wioślarz  
Pylon/Rower

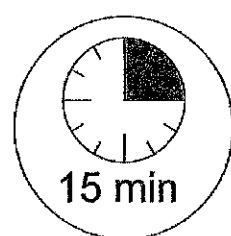
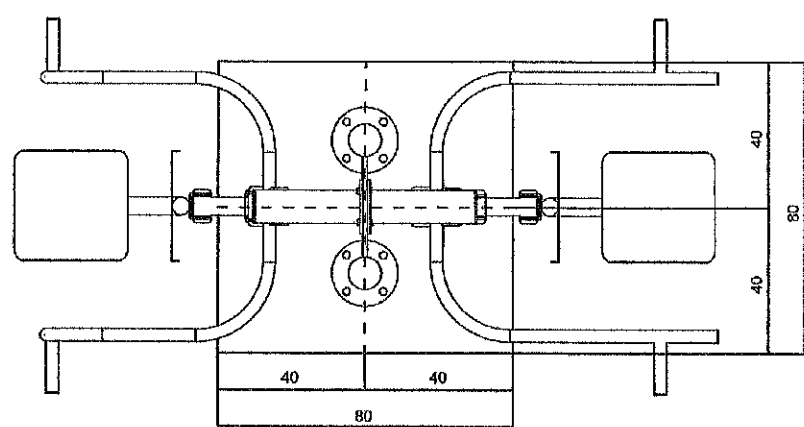
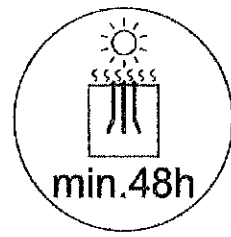
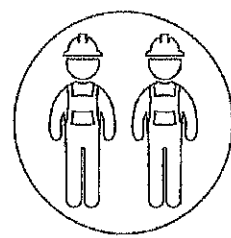
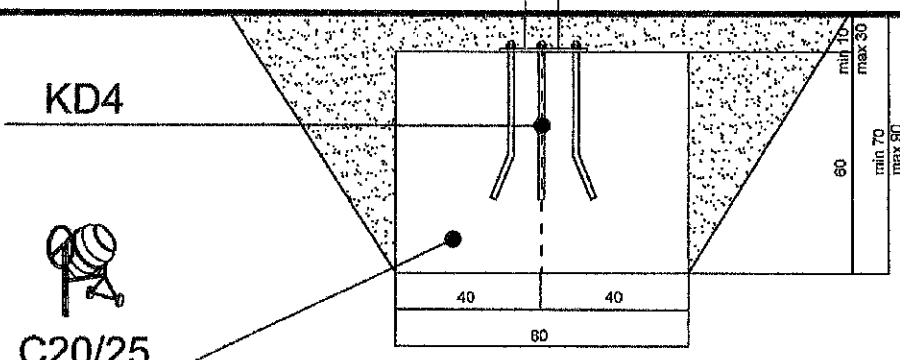
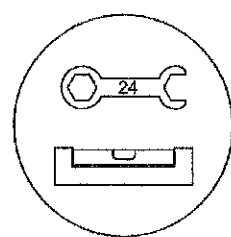
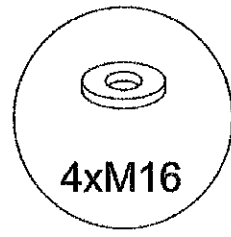
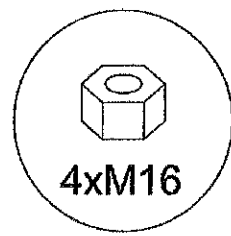
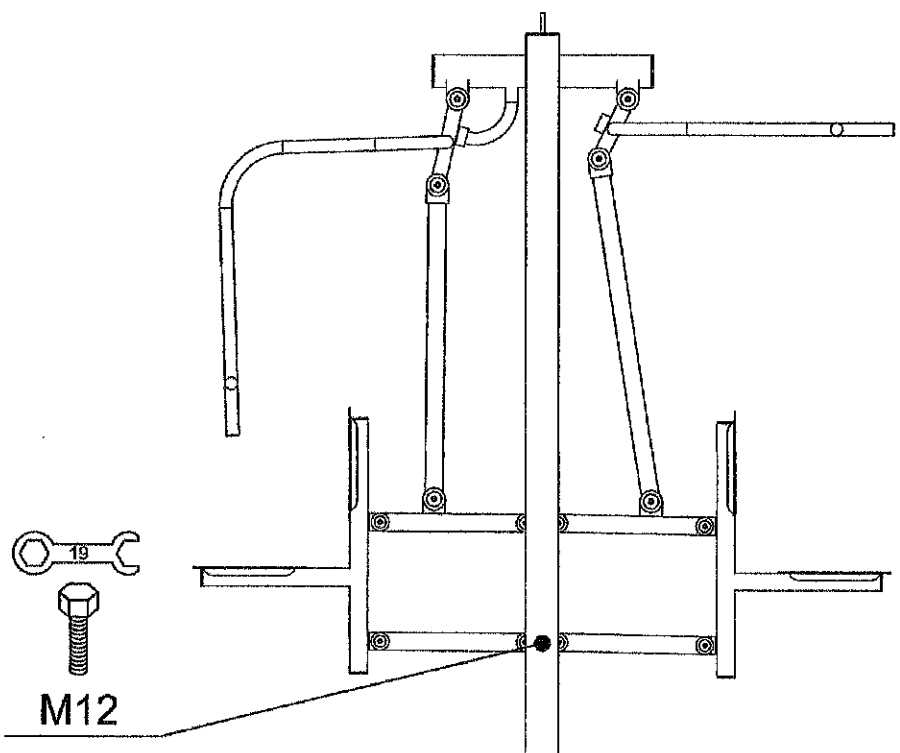





# Seria FIT PRO

Plan fundamentowania

Footing plan

Pylon/Wioślarz  
Pylon/Rower

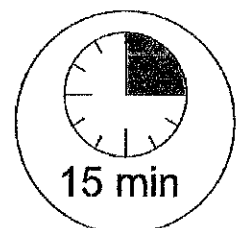
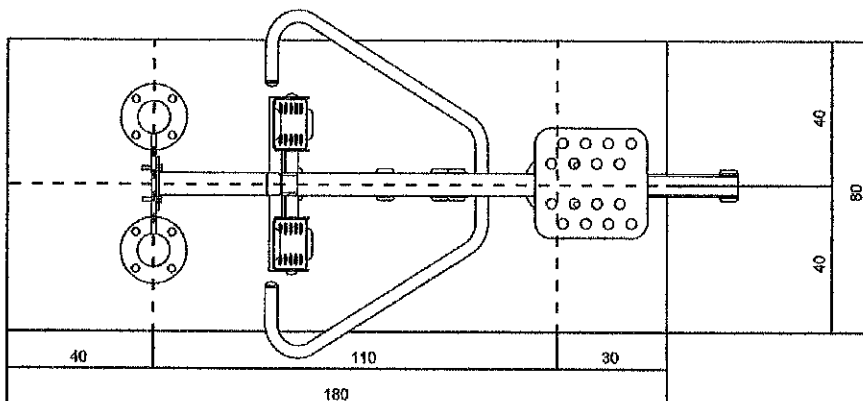
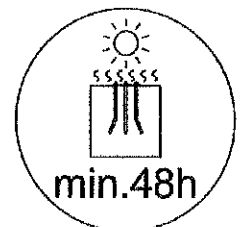
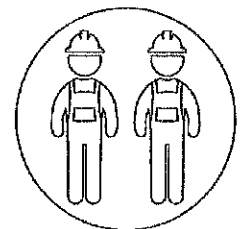
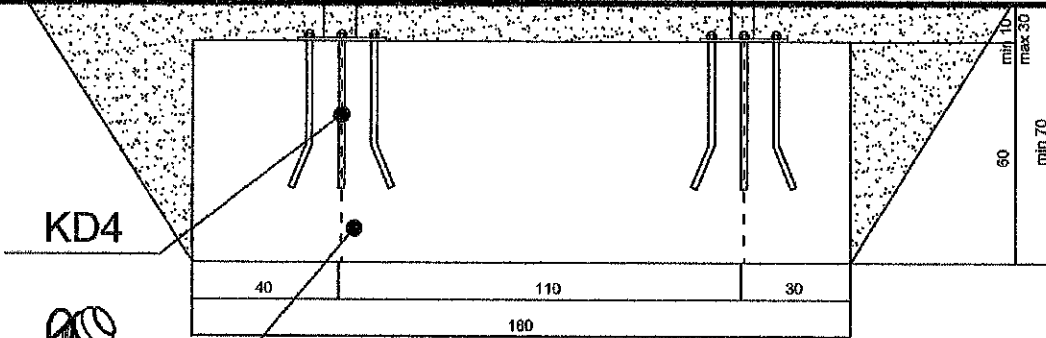
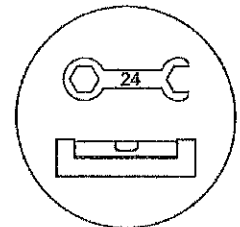
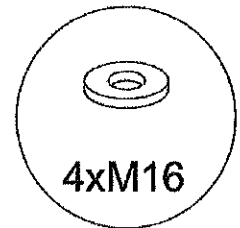
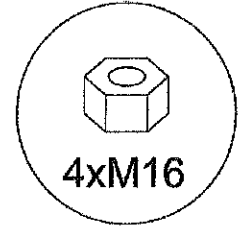
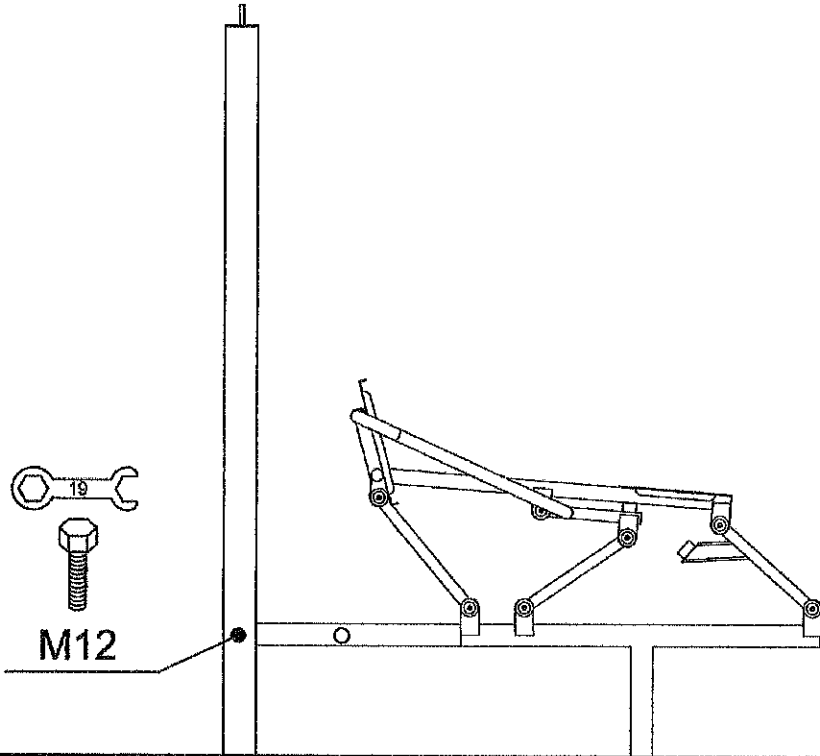





# Seria FIT PRO

Plan fundamentowania

HUSE

Footing plan

Pylon/Orbitrek  
Pylon/Crosstrainer

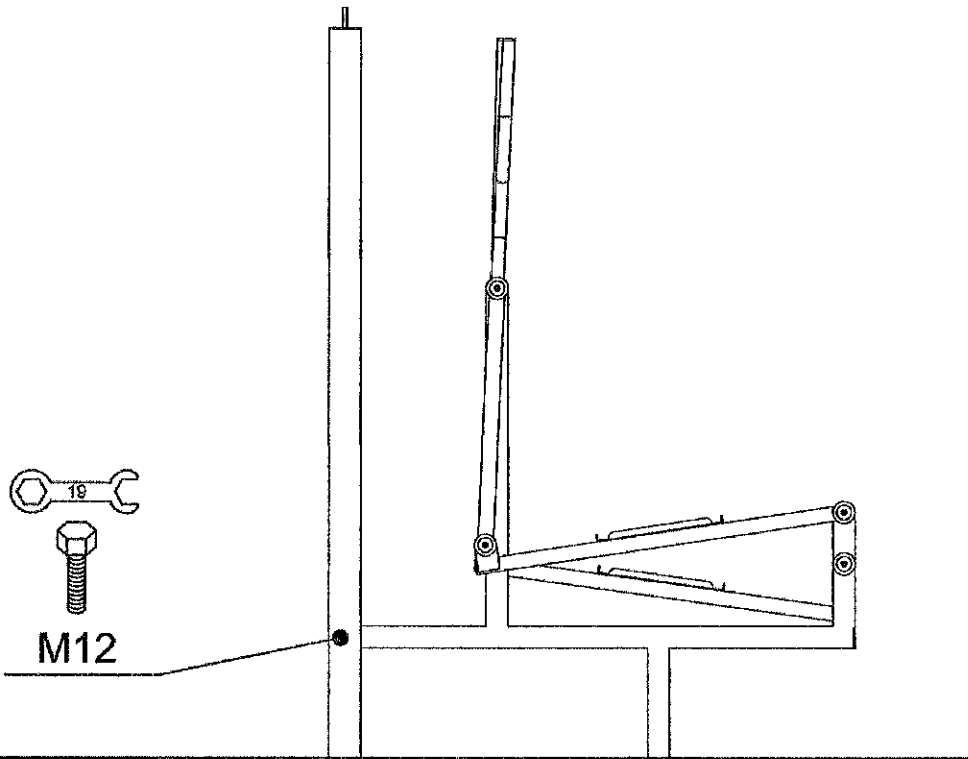

M12

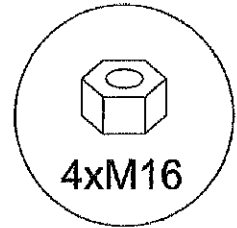

4xM16

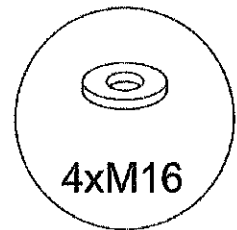

4xM16

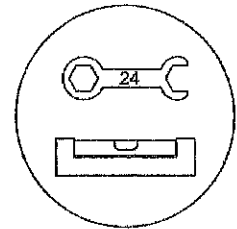

24

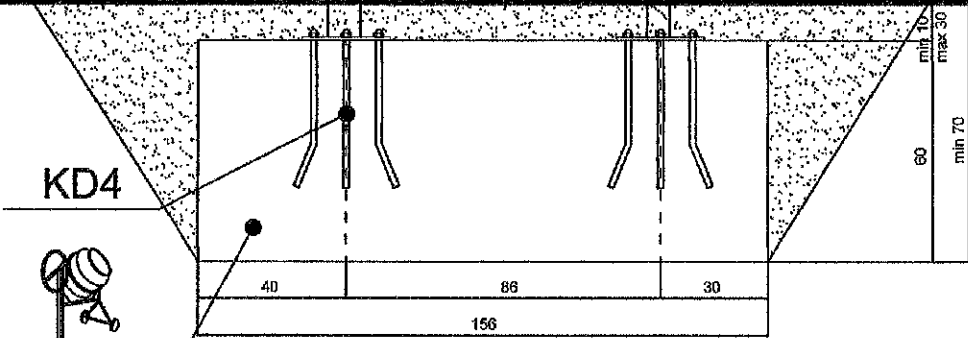

KD4



C20/25

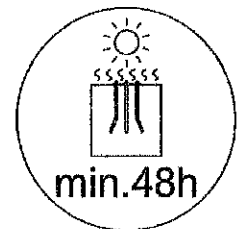
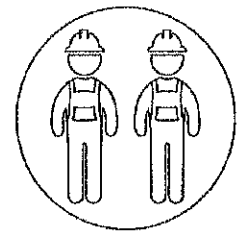

min.48h

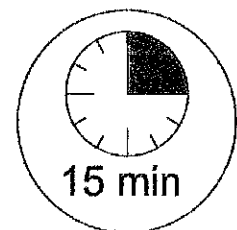

15 min

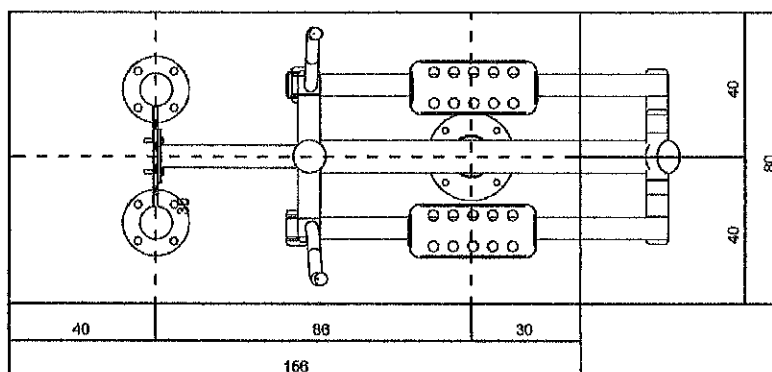







# Seria FIT PRO

Plan fundamentowania

Footing plan

## Drabinka/Pylon/Podciąg Nóg

Ladder/Pylon/Legs Raise

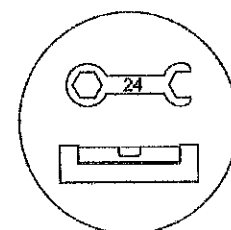
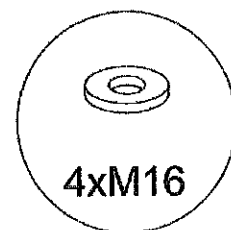
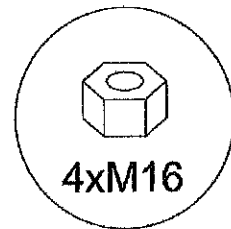
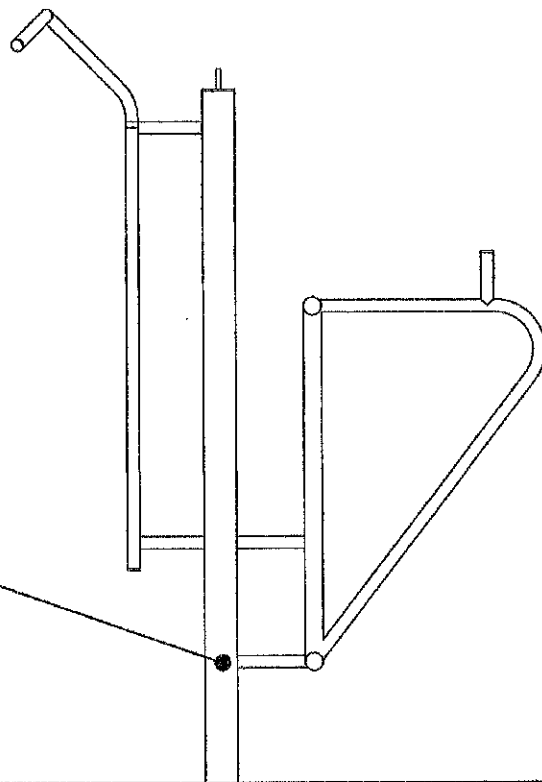
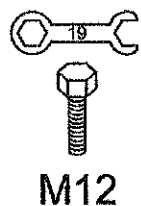

KD4



C20/25

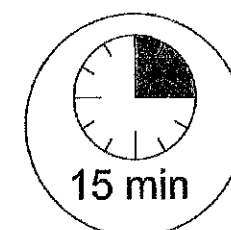
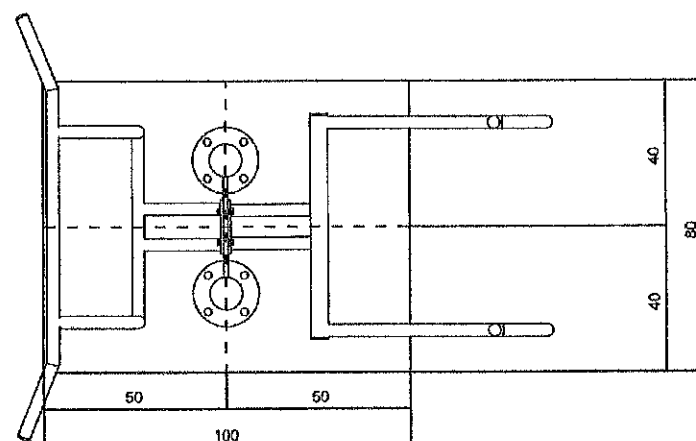
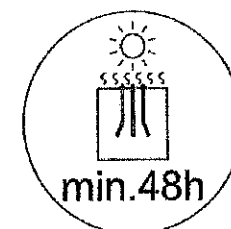
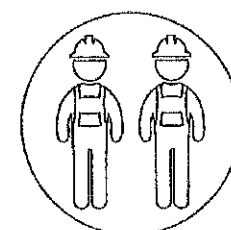
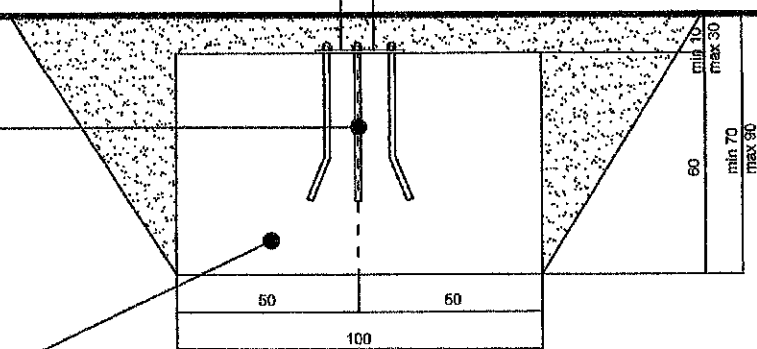





# Seria FIT PRO

Plan fundamentowania

Footing plan

Pylon/Biegacz  
Pylon/Air Walker

